

EN

OPERATING MANUAL
SOUND LEVEL MEASURING
DEVICE CONTROLLED VIA
SMARTPHONE



Table of contents

Notes regarding the operating manual..... 2

Safety 2

Information about the device..... 4

Transport and storage..... 5

Operation 5

Errors and faults 12

Maintenance and repair 13

Disposal 13

Notes regarding the operating manual

Symbols

 **Warning of electrical voltage**
This symbol indicates dangers to the life and health of persons due to electrical voltage.

 **Warning**
This signal word indicates a hazard with an average risk level which, if not avoided, can result in serious injury or death.

 **Caution**
This signal word indicates a hazard with a low risk level which, if not avoided, can result in minor or moderate injury.

Note
This signal word indicates important information (e.g. material damage), but does not indicate hazards.

 **Info**
Information marked with this symbol helps you to carry out your tasks quickly and safely.

 **Follow the manual**
Information marked with this symbol indicates that the operating manual must be observed.

You can download the current version of the operating manual and the EU declaration of conformity via the following link:



BS30WP



<https://hub.trotec.com/?id=43338>

Safety

Read this manual carefully before starting or using the device. Always store the manual in the immediate vicinity of the device or its site of use!

-  **Warning**
Read all safety warnings and all instructions. Failure to follow the warnings and instructions may result in electric shock, fire and / or serious injury. **Save all warnings and instructions for future reference.**
This appliance can be used by children aged from 8 years and above and persons with reduced physical, sensory or mental capabilities or lack of experience and knowledge if they have been given supervision or instruction concerning use of the appliance in a safe way and understand the hazards involved. Children shall not play with the appliance. Cleaning and user maintenance shall not be made by children without supervision.
- Do not use the device in potentially explosive rooms.
 - Do not use the device in aggressive atmosphere.
 - Do not immerse the device in water. Do not allow liquids to penetrate into the device.
 - The device may only be used in dry surroundings and must not be used in the rain or at a relative humidity exceeding the operating conditions.
 - Protect the device from permanent direct sunlight.
 - Do not expose the device to strong vibrations.
 - Do not remove any safety signs, stickers or labels from the device. Keep all safety signs, stickers and labels in legible condition.
 - Do not open the device.
 - Only use the device, if sufficient safety precautions were taken at the surveyed location (e.g. when performing measurements along public roads, on building sites etc.). Otherwise do not use the device.
 - Observe the storage and operating conditions as given in the Technical data chapter.

Intended use

Use this device in combination with a terminal device that is compatible with the installed Trotec MultiMeasure Mobile app. Only use the device for sound level measurements within the measuring range specified in the technical data. Observe and comply with the technical data.

The Trotec MultiMeasure Mobile app on the terminal device is used for both operation and the evaluation of the measured values.

Data logged by the device can be displayed, saved or transmitted either numerically or in form of a chart.

To use the device for its intended use, only use accessories and spare parts which have been approved by Trotec.

Improper use

Do not use the device in potentially explosive atmospheres, for measurements in liquids or on live parts.

Radio waves may interfere with the operation of medical equipment and cause malfunctions. Do not use the device near medical equipment or within medical institutions.

Persons with pacemakers must observe a minimum distance of 20 cm between the pacemaker and the device.

Also do not use the device near automatically controlled systems such as alarm systems and automatic doors. Radio waves may interfere with the operation of such equipment and cause malfunctions. Make sure that no other devices are malfunctioning during the use of your device.

Any unauthorised changes, modifications or alterations to the device are forbidden.

Personnel qualifications

People who use this device must:

- have read and understood the operating manual, especially the Safety chapter.

Residual risks



Warning of electrical voltage

Work on the electrical components must only be carried out by an authorised specialist company!



Warning

Risk of hearing damage!
Ensure sufficient ear protection when there are sources of loud sound. There is a danger of hearing damage.



Warning

Risk of suffocation!
Do not leave the packaging lying around. Children may use it as a dangerous toy.



Warning

The device is not a toy and does not belong in the hands of children.



Warning

Dangers can occur at the device when it is used by untrained people in an unprofessional or improper way!
Observe the personnel qualifications!



Caution

Keep a sufficient distance from heat sources.

Note

To prevent damages to the device, do not expose it to extreme temperatures, extreme humidity or moisture.

Note

Do not use abrasive cleaners or solvents to clean the device.

Information about the device

Device description

Used in combination with Trotec's MultiMeasure Mobile app the sound level measuring device permits the measurement of noise emissions.

In case of individual measurements, the measurement value display can be refreshed both via the app and by a brief actuation of the measurement button at the measuring device.

Apart from the hold function, the measuring device can indicate minimum, maximum and average values and carry out series measurements.

In the app you can specify MAX and MIN alarm thresholds for all parameters measured with the device.

The measurement results can be displayed and saved on the terminal device either numerically or in form of a chart. Then, the measurement data can be sent in PDF or Excel format.

The app also includes a report generation function, an organiser function, one for customer management and further analysis options. Moreover, it is possible to share measurements and project data with colleagues in another subsidiary. If MultiMeasure Studio Professional is installed on a PC, you can even use report templates and ready-made text blocks for various fields of application to turn the data into professional reports.

Device depiction

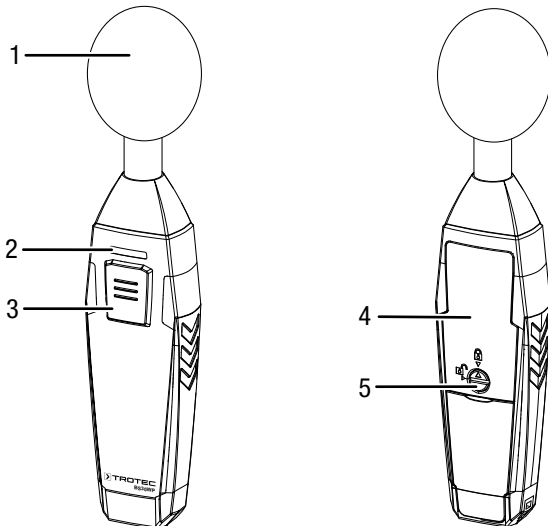

No.	Designation
1	Measuring sensor
2	LED
3	On / off / measurement button
4	Battery compartment with cover
5	Lock

Technical data

Parameter	Value
Model	BS30WP
Measuring range	35 to 130 dB(A) (31.5 Hz to 8 kHz)
Accuracy	± 3.5 dB (at 1 kHz and 94 dB)
Measuring range resolution	0.1 dB
Response time	125 ms
General technical data	
Bluetooth standard	Bluetooth 4.0, Low Energy
Transmission power	3.16 mW (5 dBm)
Radio range	approx. 10 m (depending on measuring environment)
Operating temperature	-20 °C to 60 °C / -4 °F to 140 °F
Storage temperature	-20 °C to 60 °C / -4 °F to 140 °F with <80 % RH non-condensing
Power supply	3 x 1.5 V batteries, type AAA
Device switch-off	after approx. 3 minutes without active Bluetooth connection
Protection type	IP40
Weight	approx. 180 g (incl. batteries)
Dimensions (length x width x height)	110 mm x 30 mm x 20 mm

Scope of delivery

- 1 x Digital sound level meter BS30WP
- 1 x Wind shield for microphone
- 3 x 1.5 V battery AAA
- 1 x Wrist strap
- 1 x Manual

Transport and storage

Note

If you store or transport the device improperly, the device may be damaged.

Note the information regarding transport and storage of the device.

Transport

When transporting the device, ensure dry conditions and protect the device from external influences e.g. by using a suitable bag.

Storage

When the device is not being used, observe the following storage conditions:

- dry and protected from frost and heat
- protected from dust and direct sunlight
- The storage temperature is the same as the range given in the Technical data chapter.
- Remove the batteries from the device.

Operation

Inserting the batteries

Note

Make sure that the surface of the device is dry and the device is switched off.

1. Unlock the battery compartment by turning the lock (5) in a way that the arrow points towards the opened padlock icon.
2. Remove the cover from the battery compartment (4).
3. Insert the batteries (3 batteries of type AAA) into the battery compartment with correct polarity.
4. Put the cover back onto the battery compartment.
5. Lock the battery compartment by turning the lock (5) in a way that the arrow points towards the closed padlock icon.

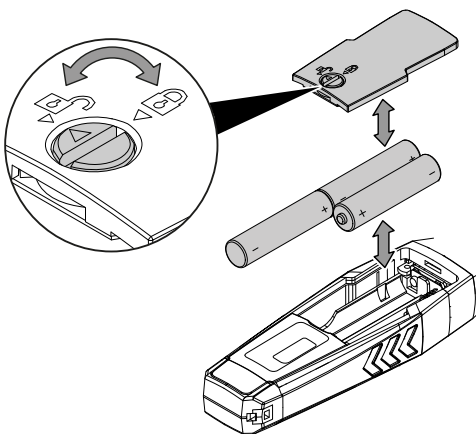

MultiMeasure Mobile app



Install the Trotec MultiMeasure Mobile app on the terminal device you want to use in combination with the appSensor.

Info

Some of the app's functions require access to your location and an active Internet connection.

The app is available for download in the Google Play Store as well as in Apple's app store and via the following link:



<https://hub.trotec.com/?id=43338>

Info

Allow for an acclimatization period of about 10 minutes in the respective measuring environment prior to the appSensor's measuring operation.

Connecting the appSensor

Info

The app can simultaneously be connected to several different appSensors or appSensors of the same type and also record several measurements at the same time.

Proceed as follows to connect the appSensor to the terminal device:

- ✓ The Trotec MultiMeasure Mobile app is installed.
 - ✓ The Bluetooth function on your terminal device is activated.
1. Start the Trotec MultiMeasure Mobile app on the terminal device.
 2. Briefly actuate the *On / off / measurement* button (3) three times to switch on the appSensor.
 - ⇒ The LED (2) flashes yellow.
 3. Press the *SENSORS* button (6) on the terminal device.
 - ⇒ The sensors overview opens.

4. Press the *Refresh* button (7).
 - ⇒ If the scanning mode was not active before, the colour of the *Refresh* button (7) will change from grey to black. The terminal device now scans the surroundings for all available appSensors.
5. Press the *Connect* button (8) to connect the desired sensor to the terminal device.
 - ⇒ The LED (2) flashes green.
 - ⇒ The appSensor is connected to the terminal device and starts measuring.
 - ⇒ The on-screen display changes to the continuous measurement.

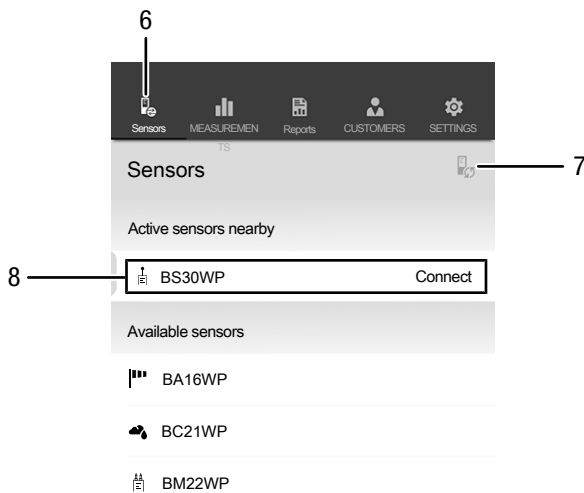

No.	Designation	Meaning
6	<i>SENSORS</i> button	Opens the sensors overview.
7	<i>Refresh</i> button	Refreshes the list of sensors near the terminal device.
8	<i>Connect</i> button	Connects the displayed sensor to the terminal device.

Continuous measurement



Info

Note that moving from a cold area to a warm area can lead to condensation forming on the device's circuit board. This physical and unavoidable effect can falsify the measurement. In this case, the app will either display incorrect measured values or none at all. Wait a few minutes until the device has become adjusted to the changed conditions before carrying out a measurement.

When the appSensor has been successfully connected to the terminal device, a continuous measurement is started and indicated. The refresh rate is 1 second. The 12 most recently measured values are displayed graphically (9) in chronological sequence. The currently determined and calculated measured values are displayed numerically (10).

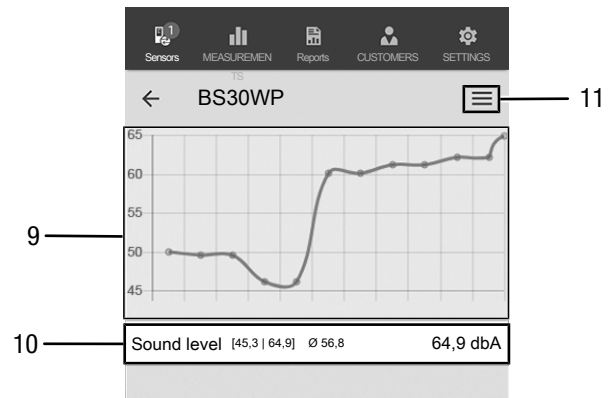

No.	Designation	Meaning
9	Graphic display	Indicates the sound level as measured over the course of time.
10	Numeric display	Indicates the minimum, maximum and average values for the sound level as well as the current value.
11	<i>Menu</i> button	Opens the menu to adjust the settings of the current measurement.

Info

The indicated measured values will not be saved automatically.

Info

By tapping on the graphic display (9) you can switch over to the numeric display and vice versa.

Measurement settings

Proceed as follows to adjust the settings for the measurement:

1. Press the *Menu* button (11).
⇒ The context menu opens.
2. Adjust the settings as required.

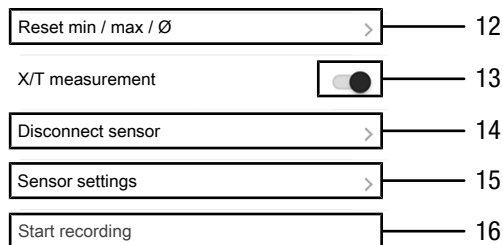
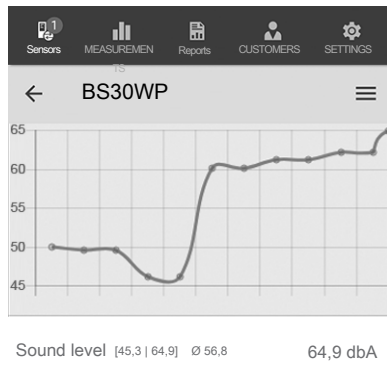

No.	Designation	Meaning
12	<i>Reset min / max / Ø</i> button	Deletes the determined values.
13	<i>X/T measurement</i> button	Switches between continuous measurement and individual measurement.
14	<i>Disconnect sensor</i> button	Disconnects the connected appSensor from the terminal device.
15	<i>Sensor settings</i> button	Opens the settings menu for the connected appSensor.
16	<i>Start recording</i> button	Starts a recording of the determined measured values for later evaluation.

Individual value measurement

Proceed as follows to select the individual value measurement as measuring mode:

1. Press the *Menu* button (11) to open the context menu for sensors.
2. Press the *X/T measurement* button (13) to switch from continuous measurement to individual value measurement.
⇒ Individual value measurement has been selected as measuring mode.
⇒ Return to the screen displaying the measured values.
⇒ The first measured value is automatically determined and displayed.

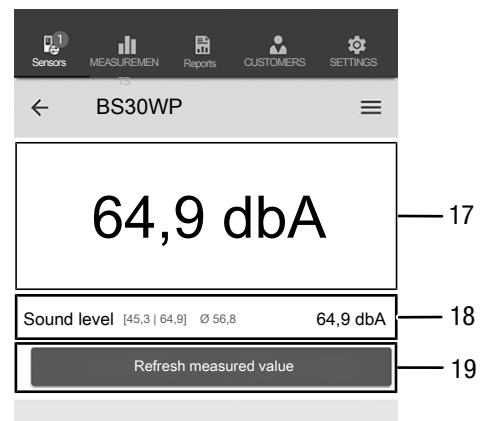

No.	Designation	Meaning
17	<i>Individual value indication</i>	Indicates the current sound level.
18	Numeric display	Indicates the minimum, maximum and average values for the sound level as well as the current value.
19	<i>Refresh measured value</i> button	Performs an individual value measurement and refreshes the displays (17) and (18).

Refreshing the measured value

Proceed as follows to refresh the measured values in the individual value measurement mode:

1. Press the *Refresh measured value* button (19) on the terminal device.
⇒ The appSensor determines the current measured value which is then displayed on the terminal device.
2. You can also press the *On / off / measurement* button (3) on the appSensor.
⇒ The appSensor determines the current measured value which is then displayed on the terminal device.

Recording measured values

Proceed as follows to record measured values for later evaluation:

1. Press the *Menu* button (11).
⇒ The context menu for sensors opens.
2. Press the *Start recording* button (16).
⇒ The *REC* button (20) replaces the *Menu* button (11).
3. If you perform a continuous measurement, the measured values determined from then on will be recorded.
4. If you perform individual value measurements, repeatedly press the *On / off / measurement* button (3) on the appSensor or the *Refresh measured value* button (19) on the terminal device until you have logged all the required measured values.

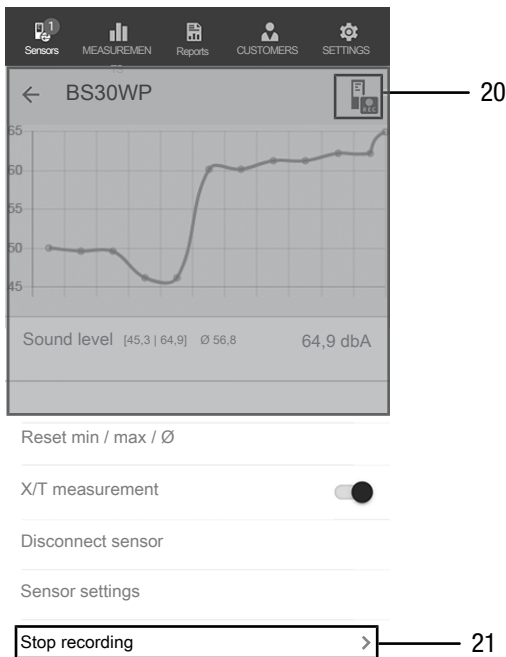

No.	Designation	Meaning
20	<i>REC</i> button	Opens the sensor settings menu.
21	<i>Stop recording</i> button	Stops the current recording of measured values. Opens the submenu for saving recordings.

Stopping a recording

Proceed as follows to stop recording the measured values:

1. Press the *REC* button (20).
⇒ The context menu for sensors opens.
2. Press the *Stop recording* button (21).
⇒ The context menu for saving the recording opens.
3. You can optionally save, discard or resume the measurement.

Saving a recording

Proceed as follows to save the recorded measured values:

1. Press the *Save* button (22) to save the recorded measured values on the terminal device.
⇒ The input mask for logging the recorded data opens.
2. Enter all the data relevant for an unambiguous assignment, then save the recording.
⇒ The recording will be saved on the terminal device.

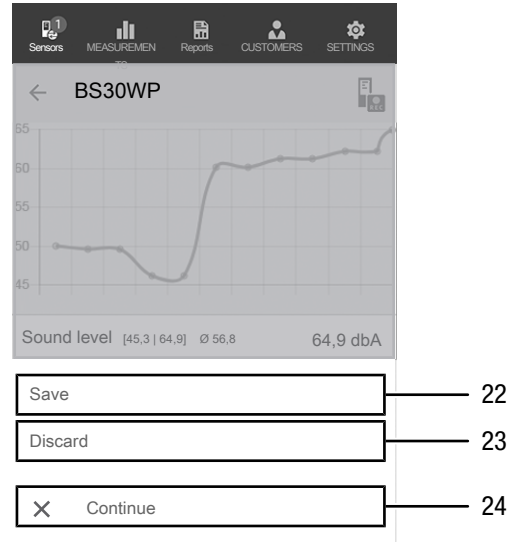

No.	Designation	Meaning
22	<i>Save</i> button	Stops the current recording of measured values. Opens the input mask for logging recording data.
23	<i>Discard</i> button	Stops the current recording of measured values. Discards the recorded measured values.
24	<i>Continue</i> button	Resumes the recording of the measured values without saving.

Analysing measurements

Proceed as follows to call up the saved measurements:

1. Press the *MEASUREMENTS* button (25).
⇒ An overview of already saved measurements will be displayed.
2. Press the *Display measurement* button (27) for the desired measurement to be indicated.
⇒ A context menu for the selected measurement opens.

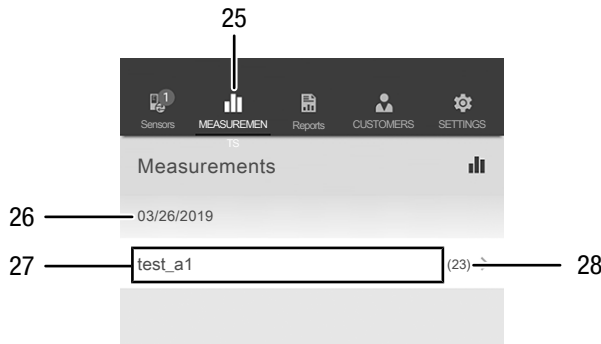

No.	Designation	Meaning
25	<i>MEASUREMENTS</i> button	Opens the overview of saved measurements.
26	Indication of the <i>date of the measurement</i>	Indicates the date on which the measurement was recorded.
27	<i>Display measurement</i> button	Opens the context menu for the selected measurement.
28	Indication of the <i>number of measured values</i>	Indicates the number of individual measured values constituting the saved measurement.

The following functions can be called up in the context menu of the selected measurement:

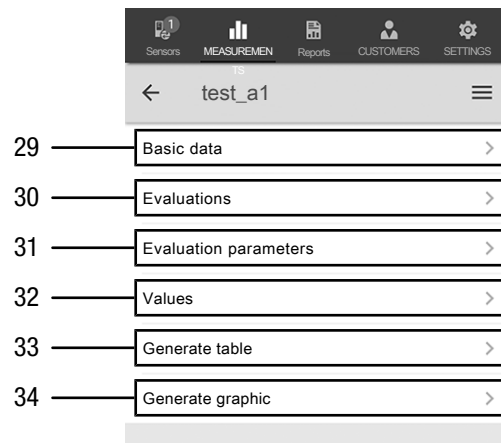

No.	Designation	Meaning
29	<i>Basic data</i> button	Opens an overview of the data saved for the measurement.
30	<i>Evaluations</i> button	Opens an overview of the evaluations generated for the measurement (graphics and tables).
31	<i>Evaluation parameters</i> button	Opens a menu to select and deselect individual evaluation parameters.
32	<i>Values</i> button	Opens a tabular overview of all the values logged for the measurement.
33	<i>Generate table</i> button	Creates a table containing the logged values of the measurement and saves it as a *.CSV file.
34	<i>Generate graphic</i> button	Creates a graphic representation of the logged values and saves it as a *.PNG file.



Info

If you have saved a previous measurement with certain parameters and then realize, that some parameters are missing, you can subsequently edit them via the menu item *Evaluation parameters*. They will not be added to the already saved measurement, to be sure, but if you save the measurement again with a different name, these parameters will be added to the initial measurement.

Generating a report

The reports generated in the MultiMeasure Mobile app are short reports providing a fast and simple documentation. Proceed as follows to generate a new report:

1. Press the *REPORTS* button (35).
⇒ The reports overview opens.
2. Press the *New report* button (36) to create a new report.
⇒ An input mask for entering all the relevant information opens.
3. Enter the information via the input mask and save the data.

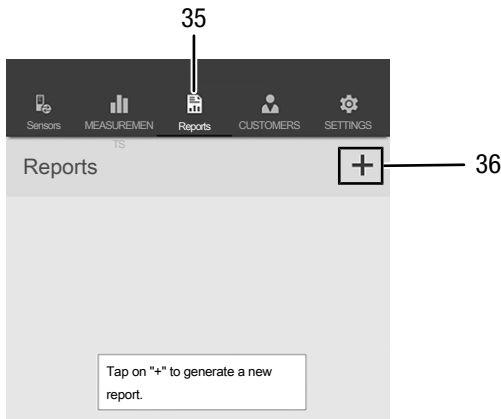

No.	Designation	Meaning
35	<i>REPORTS</i> button	Opens the overview of saved reports.
36	<i>New report</i> button	Creates a new report and opens an input mask.

Info

The customer can acknowledge the report directly in the integrated signature field.

Calling up a report

Proceed as follows to call up a created report:

1. Press the *REPORTS* button (35).
⇒ The reports overview opens.
2. Press the corresponding button (37) to display the desired report.
⇒ An input mask opens in which you can view and edit all the information.

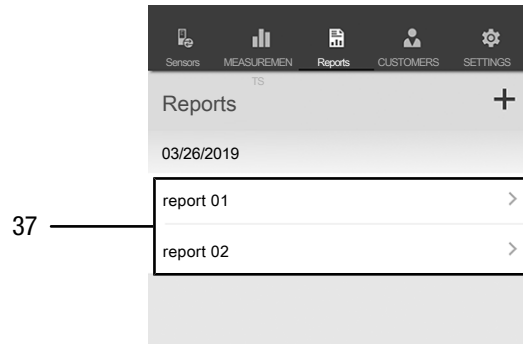

No.	Designation	Meaning
37	<i>Display REPORT</i> button	Opens the selected report.

Creating a new customer

Proceed as follows to create a new customer:

1. Press the *CUSTOMERS* button (38).
⇒ The customers overview opens.
2. Press the *New customer* button (39) to create a new customer.
⇒ An input mask for entering all the relevant information opens.
3. Enter the information via the input mask and save the data.
4. Alternatively, you can also import existing contacts from the phone book of the terminal device.

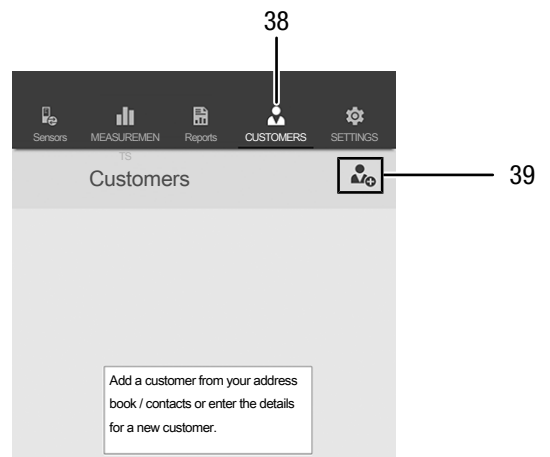

Info

You can perform a new measurement directly from the input mask.

Calling up customers

Proceed as follows to call up an already created customer:

1. Press the *CUSTOMERS* button (38).
 - ⇒ The customers overview opens.
2. Press the corresponding button (40) to display the desired customer's details.
 - ⇒ An input mask opens in which you can view and edit all the information for the selected customer as well as directly start a new measurement.
 - ⇒ The *New customer* button (39) changes. In this menu it can be used to delete the selected customer data record.



App settings

Proceed as follows to make settings in the Trotec MultiMeasure Mobile app:

1. Press the *SETTINGS* button (41).
 - ⇒ The settings menu opens.
2. Adjust the settings as required.

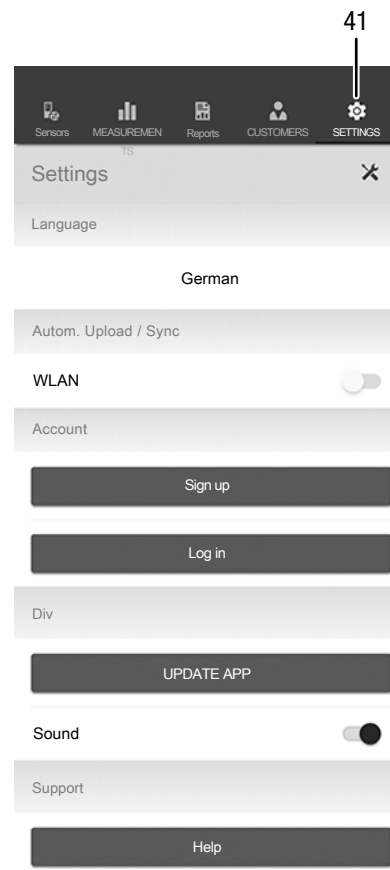

appSensor settings

Proceed as follows to adjust the settings for the appSensor:

1. Press the *SENSORS* button (6).
 - ⇒ A list of connected and available sensors will be displayed.
2. Select the line with the appSensor the settings of which you want do adjust and swipe right at the yellow marking.
3. Confirm your input.
 - ⇒ The sensor menu opens.
4. Alternatively, you can press the *SENSORS* button (6).
5. Press the *Menu* button (11).
 - ⇒ The context menu opens.
6. Press the *Sensor settings* button (15).
 - ⇒ The sensor menu opens.

Disconnecting an appSensor

Proceed as follows to disconnect an appSensor from the terminal device:

1. Press the *SENSORS* button (6).
⇒ A list of connected and available sensors will be displayed.
2. Select the line with the appSensor to be disconnected and swipe left at the red marking.
3. Confirm your input.
⇒ The appSensor is now disconnected from the terminal device and can be switched off.
4. Alternatively, you can press the *Menu* button (11).
⇒ The context menu opens.
5. Press the *Disconnect sensor* button (14).
6. Confirm your input.
⇒ The appSensor is now disconnected from the terminal device and can be switched off.

Switching off an appSensor

Info

Always terminate the connection between appSensor and app before you switch off the appSensor.

Proceed as follows to switch off an appSensor:

1. Press and hold the *On / off / measurement* button (3) for approx. 3 seconds.
⇒ The LED (2) on the appSensor goes out.
⇒ The appSensor is switched off.
2. You may now exit the Trotec MultiMeasure Mobile app on the terminal device.

Errors and faults

The device has been checked for proper functioning several times during production. If malfunctions occur nonetheless, check the device according to the following list.

Bluetooth connection is terminated or interrupted

- Check whether the LED at the appSensor flashes green. If so, briefly switch it off completely, then turn it back on. Establish a new connection to the terminal device.
- Check the battery voltage and insert new or freshly charged batteries, if required.
- Does the distance between appSensor and terminal device exceed the appSensor's radio range (see chapter *Technical data*) or are there any solid building parts (walls, pillars etc.) situated between appSensor and terminal device? Shorten the distance between the two devices and ensure a direct line of sight.

The sensor cannot be connected to the terminal device although it is displayed there.

- Check the Bluetooth settings of your terminal device. A possible reason for this could be special, manufacturer-specific settings relating to an improved location accuracy. Enable these settings, then try to establish a connection to the sensor again.

Further information and assistance regarding the used sensor type will be provided in the MultiMeasure Mobile app via the menu item *Settings => Help*. Selecting the menu item *Help* opens a link to the app's help page. You can open a drop-down menu with numerous support entries from the *Table of contents*. Optionally, you can also scroll through the entire help page and thoroughly acquaint yourself with the individual help topics.

Maintenance and repair

Battery change

A battery change is required when the LED at the appSensor flashes red or the sensor can no longer be switched on. See chapter Operation.

Cleaning

Clean the device with a soft, damp and lint-free cloth. Make sure that no moisture enters the housing. Do not use any sprays, solvents, alcohol-based cleaning agents or abrasive cleaners, but only clean water to moisten the cloth.

Repair

Do not modify the device or install any spare parts. For repairs or device testing, contact the manufacturer.

Disposal



The icon with the crossed-out waste bin on waste electrical or electronic equipment stipulates that this equipment must not be disposed of with the household waste at the end of its life. You will find collection points for free return of waste electrical and electronic equipment in your vicinity. The addresses can be obtained from your municipality or local administration. For further return options provided by us please refer to our website www.trotec24.com.

The separate collection of waste electrical and electronic equipment aims to enable the re-use, recycling and other forms of recovery of waste equipment as well as to prevent negative effects for the environment and human health caused by the disposal of hazardous substances potentially contained in the equipment.



In the European Union, batteries and accumulators must not be treated as domestic waste, but must be disposed of professionally in accordance with Directive 2006/66/EC of the European Parliament and of the Council of 6 September 2006 on batteries and accumulators. Please dispose of batteries and accumulators according to the relevant legal requirements.

Trotec GmbH

Grebbener Str. 7
D-52525 Heinsberg

☎ +49 2452 962-400

☎ +49 2452 962-200

✉ info@trotec.com

www.trotec.com