

EN

OPERATING MANUAL
DATA LOGGER
FOR EXTERNAL SENSORS



Table of contents

Content	Page
1. Safety	2
2. Intended use	2
3. Equipment	3
4. Scope of supply	4
5. Preparation before starting	4
5.1. Software	4
5.1.1. Installation conditions	4
5.1.2. Installation of the SmartGraph software	4
5.1.3. Preparing data logger configuration	4
5.2. Note at initial startup	4
6. Operation	4
6.1. Switching on and off	4
6.2. Basic settings and operating modes	4
6.2.1. The four operating modes	5
6.2.2. Network function (M51)	5
6.2.3. Factory settings (M52)	6
6.2.4. Acoustic function (M53)	6
7. Connection and configuration of external sensors	6
7.1. BUS sensors	6
7.1.1. Connection of BUS sensors	6
7.1.2. Configuration of BUS sensors (M6x)	6
7.1.3. Logging the BUS sensors (M7x) off	7
7.2. Connection of analogue sensors	7
7.2.1. Sensors for measuring voltage 0 - 1V	7
7.2.2. Sensors for measuring current, 2-cable 4 - 20 mA and 3-cable 0 - 20 mA	7
7.2.3. Pt100 sensors in 3- and 4-cable switching	8
7.2.4. Thermal elements	8
7.3. Configuration of analogue sensors (M81)	8
8. Measured values display and data recording	9
8.1. Channel groups and measuring channels	9
8.2. Processing channels for converting measured values	9
8.3. Displaying measured values	9
8.4. Data recording	9
9. Alarm function	11
9.1. Alarm configuration	11
9.2. Alarm display	11
9.3. Acoustic alarm	11
9.4. Using the alarm hysteresis	11
10. Notes on maintenance and operation	12
10.1. Battery change	12
10.2. Deleting measured data	12
10.3. Positioning for mobile use	12
10.4. Mounting on a wall	12
10.5. Moving to another site	12
10.6. Measuring accuracy	12
10.7. Installation and operation with Ethernet (with or without PoE)	12
10.8. Cleaning	12
11. Technical data	13
12. Status codes	14

In order to use your data logger according to its intended use and utilise its complete range of functions, carefully read all documentation about this device.

This **operating manual** describes the functions of the hardware.

A separate manual – the **software manual** – describes how to use the software and configure the data logger with the software and can be opened after the software has been installed by using the help function in the software.

Your new data logger was built according to current state-of-the-art technology and fulfils valid European and national directives. This conformity has been tested and the corresponding declarations and documents are kept on file by the manufacturer.

To keep this condition and ensure safe operation, as a user, you must observe the following safety instructions:

1. Safety

We accept no liability for damages caused by non-observance of this manual or unprofessional handling. Any warranty claims are voided in such cases!



Before starting the measuring device for the first time, read this manual from front to back!

For reasons of safety and conformity (CE), any unauthorised change made to the device construction or components which are to be used with the measuring device are prohibited!

Before using the device, observe the following:

- Never measure live parts.
- Observe the storage and operating conditions.
- The only party responsible for determining measured results to be valid, drawing conclusions and deriving actions is the user! The correctness of the results presented is excluded from any liability or guarantee. Liability for damages which have been caused by utilising the presented measured results is strictly excluded.

2. Intended use

The DL200X data logger is designed to detect and record a range of measured values that are detected by the measuring device and the connected external sensors. The measured data can be detected at variable selectable recording or request intervals, then saved and transmitted to a connected PC.

The measuring device may only be used for this intended use while complying with specified technical data for the measuring device and external sensors.

Any other use is considered misuse and contrary to the intended use.

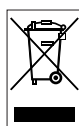

The product must not be disposed of with household waste. Dispose of this device in a manner according to the relevant legal requirements.

This release replaces all previous releases. No part of this publication may be reproduced without written permission. The same applies for electronically processing, duplicating or spreading the publication. Subject to technical changes. All rights reserved. Trademarks are used without guarantee that they may be used freely and primarily following the spelling of the manufacturer. The product names used are registered and should be treated appropriately. Changes to construction in the interests of constant improvements to the product, as well as changes to the shape and colour are reserved. The delivered product may vary from product images. This document was produced with all due care. We accept no liability whatsoever for mistakes or omissions.

3. Equipment

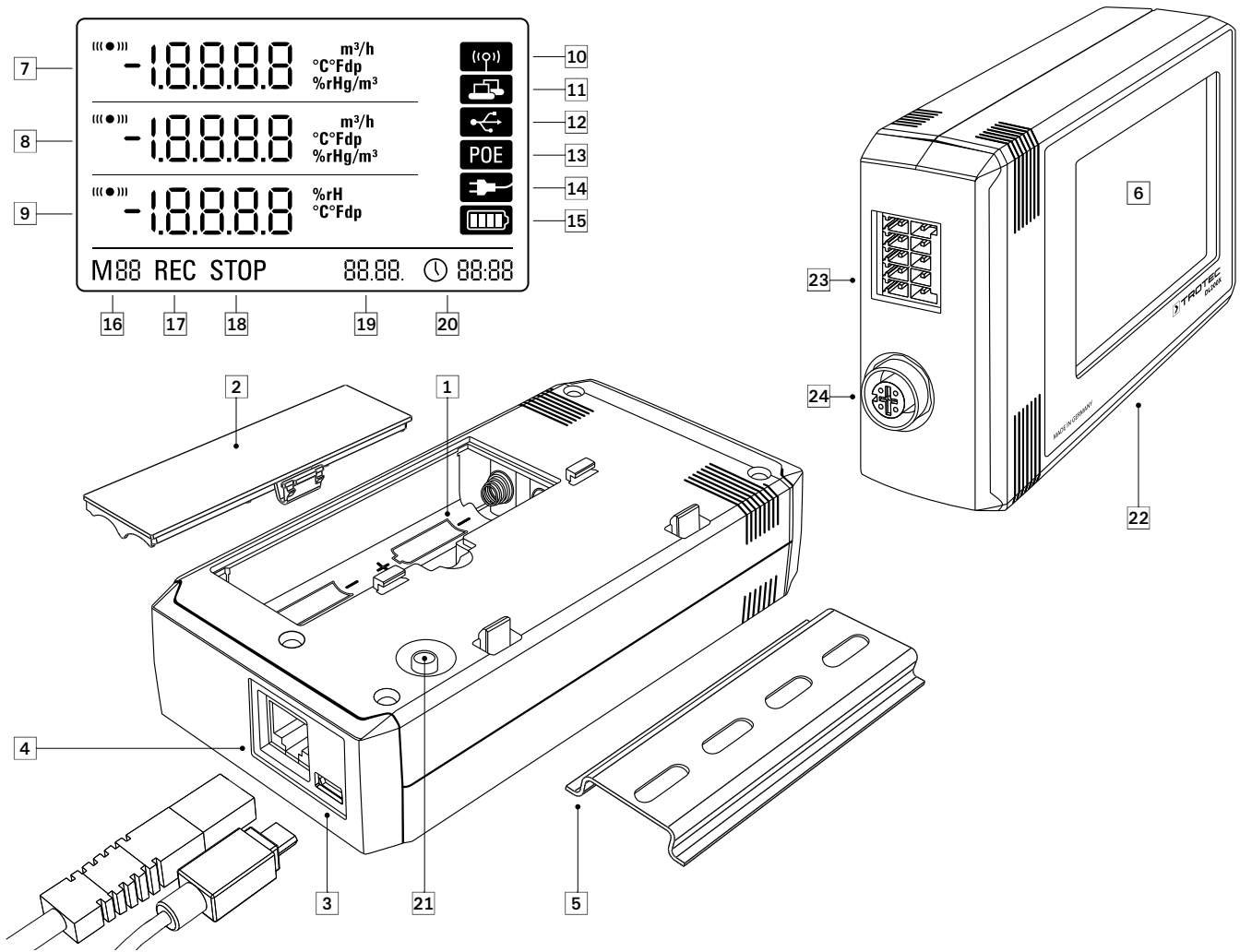

- ① Battery compartment
- ② Battery cover
- ③ PC connection USB type micro B
- ④ Network connection RJ45
- ⑤ Mount track for fastening
- ⑥ LCD display:
 - ⑦ Measured value row 1
 - ⑧ Measured value row 2
 - ⑨ Measured value row 3
 - ⑩ Display symbol for active acoustic signal
 - ⑪ Display symbol for active network connection
 - ⑫ Display symbol for active USB connection
 - ⑬ Display symbol for power supply over a network
 - ⑭ Display symbol for power supply over USB
 - ⑮ Display for battery level
 - ⑯ Display for mode marker
 - ⑰ Display for active measured value recording
 - ⑱ Display for inactive measured value recording
 - ⑲ Display for date
 - ⑳ Display for time
- ⑳ Mode selection button
- ㉑ Data logger for connecting to external sensors
- ㉒ 10-pin terminal with two independent input channels for connecting up to two analogue sensors:
 - Pin 9: Terminal C0
 - Pin 7: Terminal A0
 - Pin 5: Terminal C1
 - Pin 3: Terminal A1
 - Pin 1: Terminal +24V (input, ext. supply for data logger for stationary operation); also as external power supply
 - Pin 10: Terminal D0
 - Pin 8: Terminal B0
 - Pin 6: Terminal D1
 - Pin 4: Terminal B1
 - Pin 2: Terminal GND (Supply voltage GND)
- ㉓ 5-pin round connector M12 for connecting up to four digital BUS-compatible sensors:
 - Pin 2: Data B
 - Pin 1: Supply sensor (output)
 - Pin 3: Data A
 - Pin 4: GND (reference potential)
 - Pin 5: n.c. (not connected)

4. Scope of supply

The following components are included in the standard scope of supply:

- Data logger
- USB connection cable
- CD-ROM with operating manual, SmartGraph software and software manual
- 4 x AA batteries
- Factory certificate

5. Preparation before starting

5.1. Software

5.1.1. Installation conditions

To configure your data logger and read the recorded measured values, the SmartGraph software must be installed on a PC with the following minimum requirements.

Supported operating systems:

- Windows XP from Service Pack 3 (32 bit or 64 bit version)
- Windows Vista (32 bit or 64 bit version)
- Windows 7 (32 bit or 64 bit version)

Hardware requirements:

- Processor speed: 1 GHz, minimum
- CD-ROM drive
- USB or network connection RJ45
- 512 MB RAM, minimum
- 4 GB of free hard disk space, minimum
- Adobe Acrobat Reader software

5.1.2. Installation of the SmartGraph software

Insert the CD-ROM into your PC drive and install the software by following the instructions in the installation wizard.

5.1.3 Preparing data logger configuration

If necessary, connect the external sensors which are needed for detecting measured values to the external connections of your data logger.

Information about connecting and configuring suitable sensors is provided in chapters 7 and 11. Follow the instructions in chapter 7 for connecting external sensors and then continue with startup.

Afterwards, connect the data logger to your PC via the USB cable provided in the scope of supply. The measuring device is automatically detected by the SmartGraph software.

Alternatively, you can configure your data logger via a LAN connection over your local network if the network function is enabled. Further information about the network function is provided in chapter 6.2.2.

Start the SmartGraph software. The program automatically detects the connected data logger and adds it to the list of available data loggers. The data logger can now be configured via the software.

Further detailed information about using the software is provided in the software manual which you can open from the help function of the SmartGraph software.

5.2. Note at initial startup



After starting the device for the first time, the message "SET TIME" appears on the display. However, no settings need to be made directly on the device. The time synchronises itself with the PC time automatically when connected to the SmartGraph software for the first time.

6. Operation

The PC software SmartGraph is the central configuration interface for your data logger. All additional configuration and visualisation specifications can only be set by software.

Basic settings can be directly configured with one-button operation by using the mode selection button on your data logger.

You can restrict the one-button operation with the mode selection button from your software if necessary (key lock). It is not possible to operate your data logger with the mode selection button in this case.

6.1. Switching on and off

When current is being supplied, the data logger cannot completely switch off, but can only be set to an operating mode with minimal energy consumption (M1). In this mode, measured value detection, measured value display and data recording are inactive. An overview of the four various operating modes is provided in the next chapter.

6.2. Basic settings and operating modes

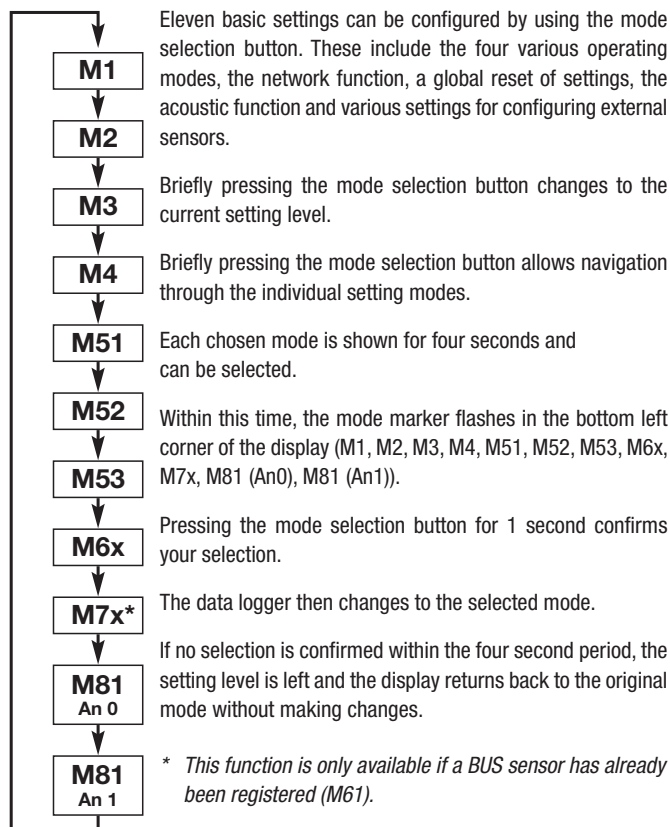

6.2.1. The four operating modes

Operating mode M1

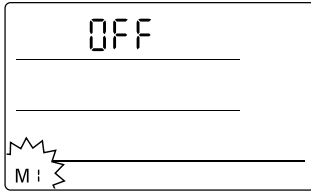

Selection of the operating mode M1

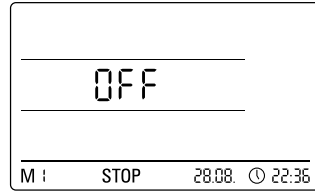

Display of the operating mode M1

Measured value recording is inactive. "OFF" is shown in the second measured value row. The STOP symbol is shown.

In this operating mode (data logger delivery state), the power consumption is minimal because measured values cannot be requested or shown.

Operating mode M2

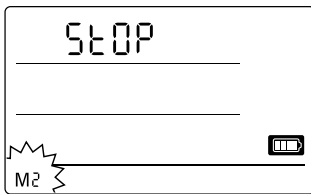

Selection of the operating mode M2

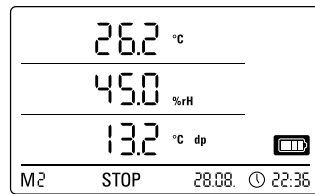

Example display of the operating mode M2

Measured value detection is active. The measured values which have been configured in the SmartGraph software are shown in all three measured value rows at the selected sensing rate.

In this operating mode, data recording is inactive; the displayed measured values are not saved in the memory. The display for measured value recording thus shows STOP (no data recording).

Operating mode M3

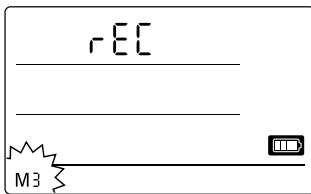

Selection of the operating mode M3

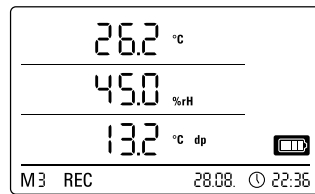

Example display of the operating mode M3

Measured value detection and data recording are active. The measured values which have been configured in the SmartGraph software are shown in all three measured value rows at the selected sensing rate.

Additionally, in this operating mode, up to twenty measuring channels, which can be selected in the SmartGraph software, are stored in the measured value memory. The display for measured value recording thus shows REC (data recording).

Operating mode M4

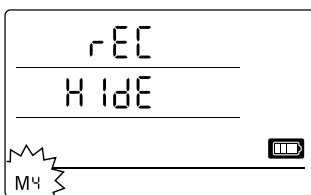

Selection of the operating mode M4

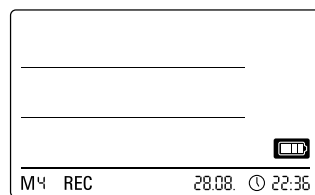

Display of the operating mode M4

Measured value detection and data recording are active; but measured value display is inactive.

Measured values are not shown in any of the three measured value rows. Still, in this operating mode, up to twenty measuring channels, which can be selected in the SmartGraph software, are stored in the measured value memory. The display for measured value recording thus shows REC (data recording).

6.2.2. Network function (M51)

Requirements for connecting over a IPv4 network.

To automatically identify the IP configuration of a data logger (which has received an IP address in the IP network via DHCP for example), it is necessary that UDP broadcasts are allowed through the network.

 **Note:** Based on their concept, UDP broadcasts do not operate through a router (NAT), but instead only within its own network. If the data logger is outside of the network, using fixed IP addresses through a system administrator is highly recommended.

Connect to the network

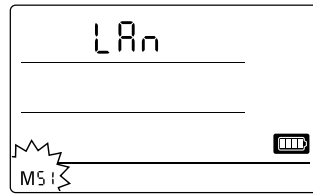

Selection of the network function M51

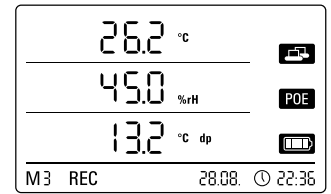

Example display of the network function M51

If the data logger is connected to a local network and the network function is activated, then software configuration and data reading from the data logger can be carried out over the network.

A signal which is broadcast from the data logger over UDP allows the SmartGraph software to automatically find the measuring device in the local network.

The first time that the data logger is connected to the network (add network device), it may be necessary to adjust the data logger's network settings to the configuration of the available network in the SmartGraph software. The factory preset is DHCP.

Further information about the network function is provided in the software manual which you can open from the help function of the SmartGraph software.

With the professional version of the SmartGraph software, it is also possible to retrieve and log current and saved measured values of the data logger in adjustable request intervals over the network.

Use in network mode

For continuous use of the network card, the data logger must be mounted on a wall. There must be a free air convection within a gap of a half metre and the zone must not be interrupted by external sources of convection (fans, lighting etc.).

Power supply in network mode

Using the network card, which is built into the data logger, raises the power consumption of the measuring device.

When the device is running on batteries alone and not connected to an external power supply, it automatically deactivates the network function after 12 minutes pass without communicating with the network. In this case, the network function must be restarted by an external power supply either manually or automatically.

 **When using the data logger in LAN mode, the power should thus be supplied by the USB power supply.**

In the optionally available PoE design, the data logger can have its power supplied directly over the network connection.

Information for system administrators

Broadcast over UDP:

PC sends toUDP:255.255.255.255:52010
(data logger receives at UDP port 52010*)

data logger replies toUDP:255.255.255.255:52005
(PC receives at UDP port 52005*)

Data transmission over TCP:

data logger receives at TCP port 52015*

* The ports can be reconfigured, but this is not recommended.

Open or lost TCP connections are closed by the data logger after a TCP timeout of 120 seconds.

6.2.3. Factory settings (M52)

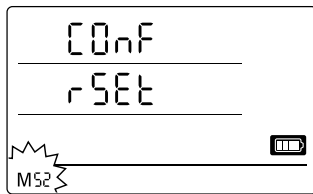

Selection of the reset function M52

This function resets the device settings to factory settings.

Even when resetting the device to factory settings or when there are no batteries in the device, the measurement data remains in the memory and is not deleted.

Information about deleting the measured data is provided in chapter 9.2.

6.2.4. Acoustic function (M53)

Activating or deactivating the acoustic function switches the data logger's acoustic signal either on or off. If the acoustic function is active, the function's display symbol is shown on the display.

When the acoustic function is active, alarm results are indicated as a tone, provided an active alarm has been preset for one or more of the three display measured values in the SmartGraph software.



Selection of the acoustic function M53

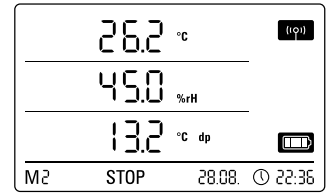

Example display of the acoustic function M53

If the acoustic function is not active, then none of the navigations steps which require the mode selection button on the data logger to be pressed are acknowledged by a tone. The same applies for selecting a mode.

If no selection is made, and thus the setting level is exited, then a tone is also emitted.

7. Connection and configuration of external sensors

The data logger has a 5-pin round connector M12 for connecting digital BUS-compatible sensors (BUS-sensor) and also has a 10-pin terminal with two independent input channels for connecting up to two analogue sensors.

7.1 BUS sensors

7.1.1 Connection of BUS sensors

Attach the BUS sensor to the 5-pin round connector of the data logger (see 24, chapter 3). The sensor is supplied with current via the plug.

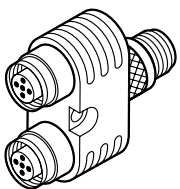

By optionally using up to three Y-distributors, a maximum of four digital BUS sensors can be connected to the data logger.

Further information about the currently available BUS sensors is provided in the technical data in chapter 11.

7.1.2 Configuration of BUS sensors (M6x)

So that BUS sensors can be used with the data logger, each BUS sensor must first be registered at the data logger individually.

It is only possible to configure if the data logger is not in logging mode (M3 or M4)!

The BUS sensors can be configured at the data logger as described below or otherwise, directly in the SmartGraph software. Further detailed information about configuration of the BUS sensors in the software is provided in the software manual which you can open by using the help function of the SmartGraph software.

To configure at the data logger, connect the first BUS sensor to be registered to the 5-pin round connector 24 of the data logger and then use the mode selection button to navigate to the configuration mode M6x – as described in chapter 6.2. The option for registering the BUS sensor is shown on the display (n1 for the first sensor to n4 for the fourth sensor).

Briefly pressing the mode selection button starts registration of the BUS sensor. The display then changes to the scan mode and the connected BUS sensor is automatically detected and identified.

At identification, the sensor is assigned a four-digit BUS ID. The first two digits of the ID represent the sensor type (e.g. 71 for TFF sensors). The last two digits represent the sensor number and are automatically assigned according to the order of registration – 01 for the first to 04 for the fourth registered sensor.

After sensor registration, a message is displayed with information about the BUS ID – the message symbol in the bottom right corner of the display flashes. Briefly pressing the mode selection button closes the message.



Tip: Note the BUS ID for measuring in the future directly on the sensor.

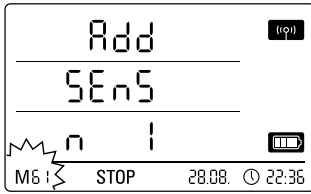

Example display: Registration function M61 selection for registering the first BUS sensor (n1).

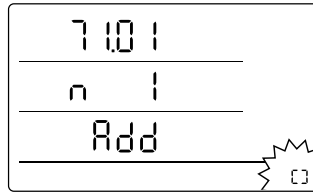

Example display: Message specifying the BUS ID (71.01) for the first registered BUS sensor.

Important: If several sensors are used, each sensor must first be individually connected to the data logger, registered and assigned a BUS ID in this manner. The registration process cannot be carried out if more than one sensor is connected to the BUS!

Thus, ensure that only the applicable sensor is connected to the BUS for registration.

This restriction only applies for the registration process. After all sensors have been individually registered, it is possible to use several BUS sensors without difficulty, of course.

Otherwise, the BUS sensors can be configured directly in the SmartGraph software.

Further detailed information about configuration of the BUS sensors in the software is provided in the software manual which you can open by using the help function of the SmartGraph software.

7.1.3 Logging the BUS sensors (M7x) off

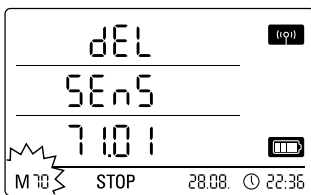

Example display: Log off function M70 selection for logging off the first selected sensor.

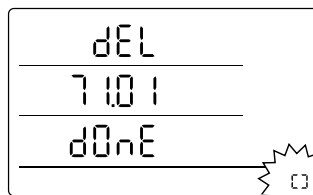

Example display: Message specifying the BUS ID (71.01) for the logged off BUS sensor.

To log off a registered BUS sensor from the data logger again, use the mode selection button to navigate to the configuration mode M7x. The option for removing the first BUS sensor is shown on the display.

To log off, it is not necessary to connect the sensor to the device!

If several BUS sensors had already been connected and a BUS sensor which is not the first is to be removed, press the mode selection button until the BUS ID shows the sensor to be removed.

Briefly pressing the mode selection button now starts BUS sensor log off. After sensor log off, a message is displayed with information about the BUS ID – the message symbol in the bottom right corner of the display flashes. Briefly pressing the mode selection button closes the message.

7.2 Connection of analogue sensors

The data logger has a 10-pin terminal with two independent input channels for connecting up to two analogue sensors. Input channel 1 has pins 1, 3, 5, 7 and 9 while input channel 2 has pins 2, 4, 6, 8 and 10 (see 23, chapter 3).

Both of the input channels support the sensor configurations listed in the following subchapters.

7.2.1 Sensors for measuring voltage 0 - 1V

The sources of voltage are connected with the positive pole at terminal B and with the negative pole at terminal A, as shown in the diagram:

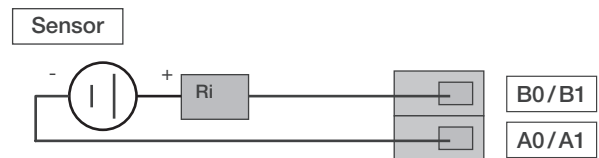

Important: The voltage input is a real difference input. If the sensor is connected to the data logger via cables which are too long, it might be necessary to connect the sensor via shielded cabling. The cable shield should be connected to the GND terminal.

To register and configure sensors for measuring voltage at the data logger, follow the instructions in chapter 7.3.

7.2.2 Sensors for measuring current, 2-cable 4 - 20 mA and 3-cable 0 - 20 mA

The switching supports current measurement in 2-cable and 3-cable operation. For 2-cable operation, sensor supply and supply for the DL200X must have identical reference potential. In 2-cable and 3-cable operation, the sensor current is fed into the A0/A1 terminal.

Wiring diagram for measuring current in 2-cable operation:

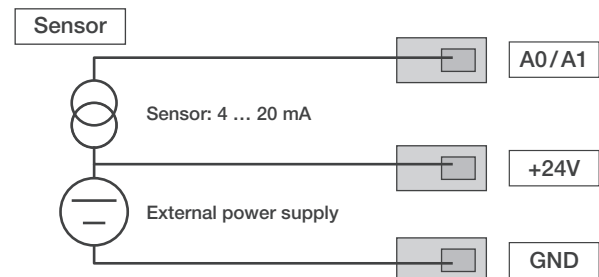

The sensor current is converted into voltage in the DL200X at a load. The load has a resistance of <math>< 50 \Omega</math>. Both the sensor and the DL200X can be supplied via an external source of voltage.

Wiring diagram for measuring current in 3-cable operation:

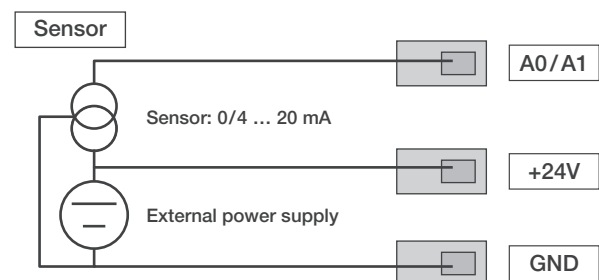

This switching is used for sensors whose own current usage is over 4 mA, such as gas sensors for example.

To register and configure sensors for measuring current at the data logger, follow the instructions in chapter 7.3.

7.2.3 Pt100 sensors in 3- and 4-cable switching

For 3-cable switching, the Pt100 is connected to the measurement switching via 3 cables. The measuring current is fed into the sensor via the D0/D1 cable. The resistance of the Pt100 is determined from the terminal voltages B0/B1, C0/C1 and D0/D1:

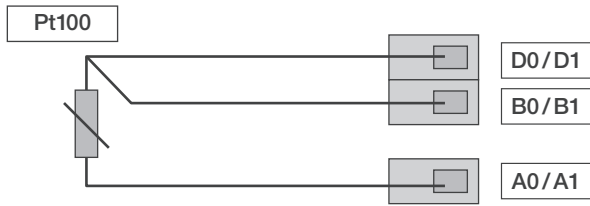

Important: The DL200X is able to compensate cable resistances up to 10 Ω. The compensation typically reduces the influence of the cable resistance by a factor of 100.

For 4-cable switching, the Pt100 is connected to the measurement switching via 4 cables. The measuring current is fed into the sensor via the D0/D1 and C0/C1 cable. The resistance of the Pt100 is determined from the terminal currents B0/B1, A0/A1:

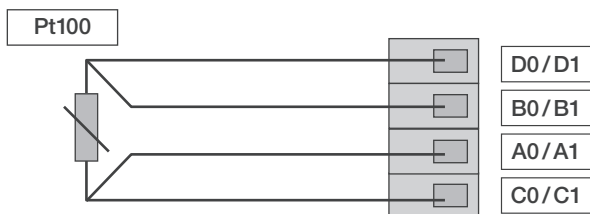

For exact temperature measurements, 4-cable switching is recommended.

To register and configure Pt100 sensors at the data logger, follow the instructions in chapter 7.3.

7.2.4 Thermal elements

The data logger supports the connection of thermal elements of the types J, K and S. The thermal element is connected with the positive pole at terminal B and with the negative pole at terminal A:

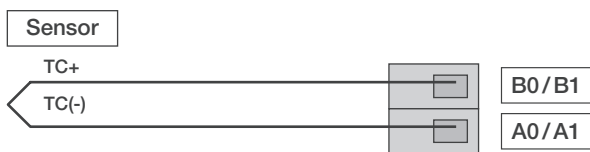

Important: When connecting thermal elements, observe the polarity.

To register and configure thermal elements at the data logger, follow the instructions in chapter 7.3.

7.3 Configuration of analogue sensors (M81)

So that analogue sensors can be used with the data logger, their specification at the data logger must be configured correctly.

It is only possible to configure if the data logger is not in logging mode (M3 or M4)!

To configure the sensors, use the mode selection button to navigate to the configuration mode M81 (AN0) – as described in chapter 6.2 – in order to configure the specification of a sensor for the first input channel. Alternatively, navigate to the configuration mode M81 (AN1) to configure the specification of a sensor for the second input channel. The option for configuring the first analogue sensor is shown on the display.

At initial startup, there is no sensor assignment preset in the factory; at later configurations, previous specifications are preset. Pressing and holding the mode selection button makes it possible to now change to the configuration menu for the analogue sensor specifications.

Press the mode selection button again until the desired sensor specification appears on the screen. Then, press and hold the mode selection button to confirm the desired sensor specification.

After sensor registration, a message is displayed with information about the desired sensor configuration – the message symbol in the bottom right corner of the display flashes. Briefly pressing the mode selection button closes the message.

Example LCD displays of sensor specification for registering an analogue sensor at the first input channel (AN0):

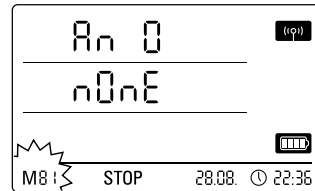

Selection for specifying no sensor assignment at the first input channel.

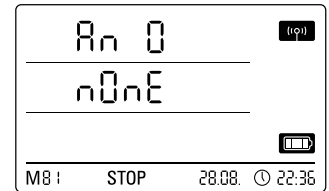

Status indicating that no sensor is registered at the first input channel.

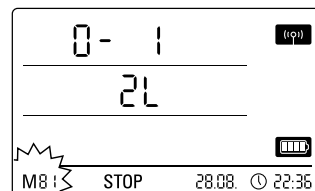

Selection of a sensor for measuring voltage 0 - 1V.

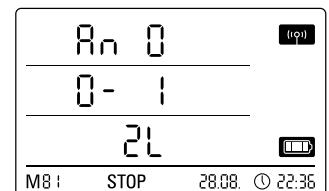

Status indicating that a sensor is registered for measuring voltage 0 - 1V at the first input channel.

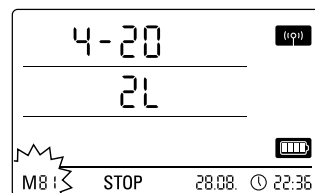

Selection of a sensor for measuring current in 2-cable operation.

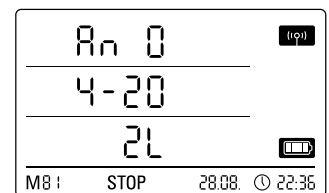

Status indicating that a sensor is registered for measuring current in 2-cable operation at the first input channel.

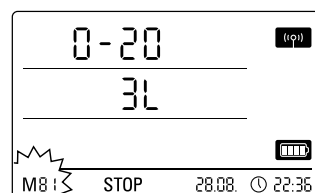

Selection of a sensor for measuring current in 3-cable operation.

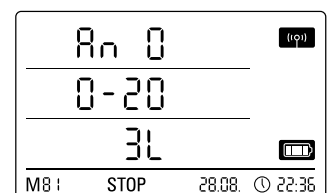

Status indicating that a sensor is registered for measuring current in 3-cable operation at the first input channel.

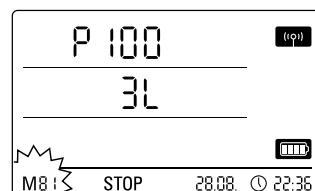

Selection of a Pt100 sensor in 3-cable operation.

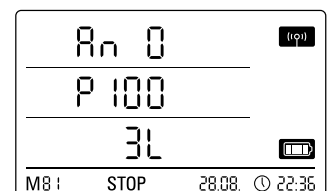

Status indicating that a Pt100 sensor is registered in 3-cable operation at the first input channel.

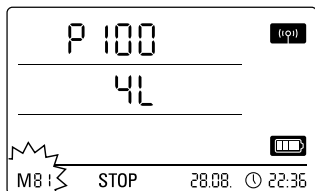

Selection of a Pt100 sensor in 4-cable operation.

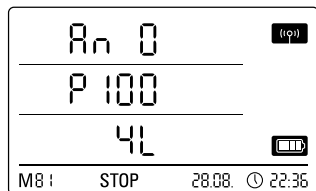

Status indicating that a Pt100 sensor is registered in 4-cable operation at the first input channel.

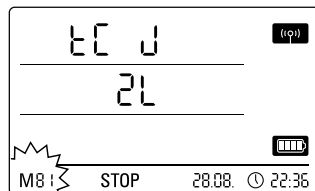

Selection of a thermal element of the J type at the first input channel.

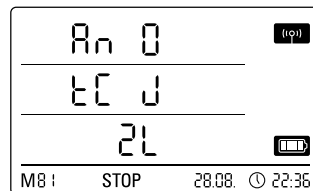

Status indicating that a thermal element of the J type is registered at the first input channel.

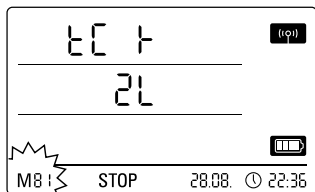

Selection of a thermal element of the K type.

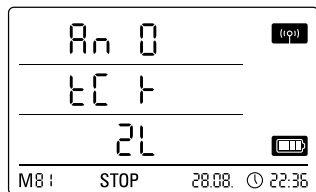

Status indicating that a thermal element of the K type is registered at the first input channel.

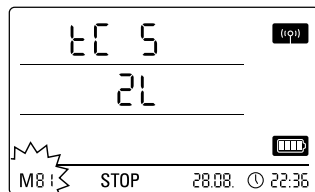

Selection of a thermal element of the S type at the first input channel.

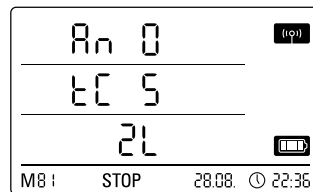

Status indicating that a thermal element of the S type is registered at the first input channel.

8. Measured values display and data recording

8.1. Channel groups and measuring channels

Each measured value in the specified measuring unit which is detected by a connected sensor represents a channel group.

A temperature sensor with the specifiable measuring units °C or °F represents for example two channel groups (temperature °C and temperature °F).

The amount of channel groups which can be detected by a BUS sensor depends on the sensor design. The BUS sensor of the TFF type can detect seven different channel groups for example.

Analogue sensors for measuring voltage and current can only detect one channel group each; analogue sensors for measuring temperature can detect two channel groups (°C and °F).

For each channel group, there are then four measuring channels for recording: Current measured value (cur), minimum measured value (min), maximum measured value (max) and average measured value (mid).

When all sensors are assigned with a total of four connected BUS sensors of the TFF type and two connected analogue Pt100 sensors, the data logger can detect a total of 32 channel groups and 128 measuring channels, as shown in table 2.

8.2 Processing channels for converting measured values

With the SmartGraph software, analogue sensors which supply a current or voltage value can be used as processing channels for converting measured values. Processing channels make it possible to convert the input values of analogue sensors which supply a current or voltage value into the actual measured value. Measuring unit, conversion parameter and decimal points can be specified for each processing channel and assigned to a sensor type (see table 1).

Further detailed information about configuration of the processing channels in the software is provided in the software manual which you can open by using the help function of the SmartGraph software.

8.3. Displaying measured values

One of the channel groups specified in table 1 for displaying measured values can be configured to be displayed on each of the three measured value rows. Here, the current measured value is always shown on the display.

8.4. Data recording

If either of the operating modes M3 or M4 are selected, then the data logger is in logging mode (REC) and the measured values of the measuring channels selected for recording are saved in the device.

Up to 20 of the measuring channels specified in table 2 can be simultaneously recorded in the data memory of the measuring device.

Recording begins immediately from the moment that the operating mode M3 or M4 is selected and is carried out in ring mode. This means that when the memory limits are reached, the recording does not stop but continues to record. The older values are simply overwritten by the newest measured values.



Tip: Current, minimum, maximum and average measured values for a channel group each represent one measuring channel. If these values should be available for later documentation and evaluation, each of the measuring channels must already be selected during memory organisation for recording, because it is not possible to calculate these values in the software.

The specifications for type, duration and scope of data recording in the logging mode can be individually set in the software. Detailed information is provided in the software manual.

Table 1: Available processing channels for converting measured values

associable units:	counts, logic, digits, °C, °F, K, °Cdp, °Fdp, %rH, g/kg, g/m ³ , µm, mm, cm, dm, m, km, in, mil, ft, mi, m/s, km/h, kts, ppm, mV, V, mA, A, Hz, kHz, bar, mbar, Pa, mPa, hPa, kPa, m ³ , l, s, ms, µs, %, °, mm/h, m ³ /h, l/m ² , in/h, mil/h, g, kg
associable sensor types:	temperature, relative humidity, absolute humidity, dew point, battery voltage, voltage, current, absolute air pressure, relative air pressure, building moisture, flow rate, mix ratio, CO ₂ concentration, particles 0.1 µm, particles 0.2 µm, particles 0.3 µm, particles 0.5 µm, particles 1 µm, particles 5 µm, particles 10 µm, particles x µm, particles y µm, particles z µm, unknown, inactive, wet-bulb temperature, global radiation, daylight, amount of rain, wind speed, wind direction, analogue/digital input, ground moisture, leaf wetness

Table 2: Overview of available channel groups (measured values) and measuring channels of the data logger

Sensor assignment	Sensor type	Channel group (measured value)	Unit	Available processing channels for converting measured	values Available measuring channels for data recording (max. 20 channels available for saving) and for displaying (max. 3 channels for display)			
BUS sensor 1	e.g. TFF sensor BUS class 71	Temperature	°C	–	cur	min	max	mid
		Temperature	°F	–	cur	min	max	mid
		Dew point	°C	–	cur	min	max	mid
		Dew point	°F	–	cur	min	max	mid
		Relative humidity	%	–	cur	min	max	mid
		Absolute humidity	g/m ³	–	cur	min	max	mid
		Mix ratio	g/kg	–	cur	min	max	mid
BUS sensor 2 (with Y distributor)	e.g. TFF sensor BUS class 71	Temperature	°C	–	cur	min	max	mid
		Temperature	°F	–	cur	min	max	mid
		Dew point	°C	–	cur	min	max	mid
		Dew point	°F	–	cur	min	max	mid
		Relative humidity	%	–	cur	min	max	mid
		Absolute humidity	g/m ³	–	cur	min	max	mid
		Mix ratio	g/kg	–	cur	min	max	mid
BUS sensor 3 (with Y distributor)	e.g. TFF sensor BUS class 71	Temperature	°C	–	cur	min	max	mid
		Temperature	°F	–	cur	min	max	mid
		Dew point	°C	–	cur	min	max	mid
		Dew point	°F	–	cur	min	max	mid
		Relative humidity	%	–	cur	min	max	mid
		Absolute humidity	g/m ³	–	cur	min	max	mid
		Mix ratio	g/kg	–	cur	min	max	mid
BUS sensor 4 (with Y distributor)	e.g. TFF sensor BUS class 71	Temperature	°C	–	cur	min	max	mid
		Temperature	°F	–	cur	min	max	mid
		Dew point	°C	–	cur	min	max	mid
		Dew point	°F	–	cur	min	max	mid
		Relative humidity	%	–	cur	min	max	mid
		Absolute humidity	g/m ³	–	cur	min	max	mid
		Mix ratio	g/kg	–	cur	min	max	mid
Analogue sensor 1 at input channel 1 (An0)	Measuring voltage 0 - 1 V	Voltage	V	yes, see table 1	cur	min	max	mid
	Measuring current in 2-cable operation 4 - 20 mA	Current	mA		cur	min	max	mid
	Measuring current in 3-cable operation 0 - 20 mA	Current	mA		cur	min	max	mid
	Pt100 temperature measurement in 3-cable operation	Temperature	°C	–	cur	min	max	mid
	Pt100 temperature measurement in 3-cable operation	Temperature	°F	–	cur	min	max	mid
	Pt100 temperature measurement in 4-cable operation	Temperature	°C	–	cur	min	max	mid
	Pt100 temperature measurement in 4-cable operation	Temperature	°F	–	cur	min	max	mid
	Temperature measurement with thermal element K type	Temperature	°C	–	cur	min	max	mid
	Temperature measurement with thermal element K type	Temperature	°F	–	cur	min	max	mid
	Temperature measurement with thermal element J type	Temperature	°C	–	cur	min	max	mid
	Temperature measurement with thermal element J type	Temperature	°F	–	cur	min	max	mid
	Temperature measurement with thermal element S type	Temperature	°C	–	cur	min	max	mid
	Temperature measurement with thermal element S type	Temperature	°F	–	cur	min	max	mid
Analogue sensor 2 at input channel 2 (An1)	Measuring voltage 0 - 1 V	Voltage	V	yes, see table 1	cur	min	max	mid
	Measuring current in 2-cable operation 4 - 20 mA	Current	mA		cur	min	max	mid
	Measuring current in 3-cable operation 0 - 20 mA	Current	mA		cur	min	max	mid
	Pt100 temperature measurement in 3-cable operation	Temperature	°C	–	cur	min	max	mid
	Pt100 temperature measurement in 3-cable operation	Temperature	°F	–	cur	min	max	mid
	Pt100 temperature measurement in 4-cable operation	Temperature	°C	–	cur	min	max	mid
	Pt100 temperature measurement in 4-cable operation	Temperature	°F	–	cur	min	max	mid
	Temperature measurement with thermal element K type	Temperature	°C	–	cur	min	max	mid
	Temperature measurement with thermal element K type	Temperature	°F	–	cur	min	max	mid
	Temperature measurement with thermal element J type	Temperature	°C	–	cur	min	max	mid
	Temperature measurement with thermal element J type	Temperature	°F	–	cur	min	max	mid
	Temperature measurement with thermal element S type	Temperature	°C	–	cur	min	max	mid
	Temperature measurement with thermal element S type	Temperature	°F	–	cur	min	max	mid

9. Alarm function

9.1. Alarm configuration

An alarm function can be configured in the measuring device administration for each of the measuring channels selected for display or recording.

By defining an upper and lower alarm limit value, a value corridor is specified. This is the so-called good range and when the range is exited, an alarm sounds.

Note: The alarm function can only be represented on the display for the channel groups of the three measuring channels selected for measured value display, and only in the operating modes M2 and M3!

However, saving alarm results of other selected measuring channels in logging mode is independent of the selected display of the measured values. That means that the alarm results of the measuring channels which are not for display but for data recording are also recorded.

Even in the operating mode M4 when displaying measured values is deactivated, all preselected alarm results are recorded!

9.2. Alarm display

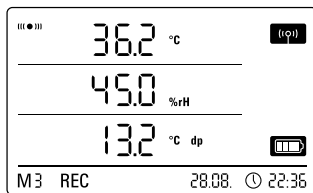

Example display for an alarm result of the measuring channel shown in the first measured value row.

The alarm display is only possible for measured values which are preselected for displaying and which have been configured with an active alarm function.

If an alarm occurs at one of these measuring channels, the alarm symbol flashes beside the measured value display for this channel while the good range is exited.

If the measured value then reaches the defined value corridor, that is, the good range, then the alarm symbol stops flashing and is shown continually.

This indicates that an alarm result occurred. If the good range is exited during the course of a measurement, the alarm symbol flashes again.

Reading the measured value memory deletes the alarm display.

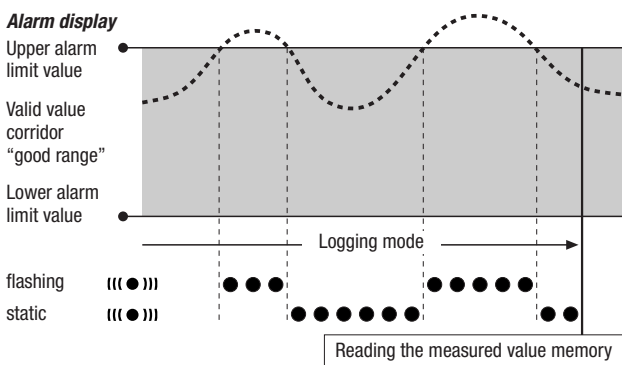

Additionally, a hysteresis can be set by which the measured value must return to the valid range to switch off the alarm.

9.3. Acoustic alarm

If an alarm goes off while the acoustic function is activated (see chapter 6.2.4. Acoustic function), then an alarm tone sounds and only stops when the measured value returns to the good range.

9.4. Using the alarm hysteresis

If you use the alarm function without alarm hysteresis, then an alarm sounds and is recorded each time the preset limit values are exceeded.

If your limit values have been selected very close to each other, then this means that an alarm situation occurs very often.

For example, if you set a room temperature of 24 °C as the upper alarm limit and a room temperature of 10 °C as the lower alarm limit and the room temperature continually deviates between 23.5 and 25 °C during the measuring period, then there will be many individual alarm signals created and recorded.

To prevent this, you can define an alarm hysteresis. With this setting, you define a value by which the measured value must have returned to the valid value corridor, the good range, in order to switch off the alarm.

If an alarm hysteresis of 1 °C was set, the alarm in the previous example would go off once as 24 °C was exceeded and then only stop as the temperature drops below 23 °C again.

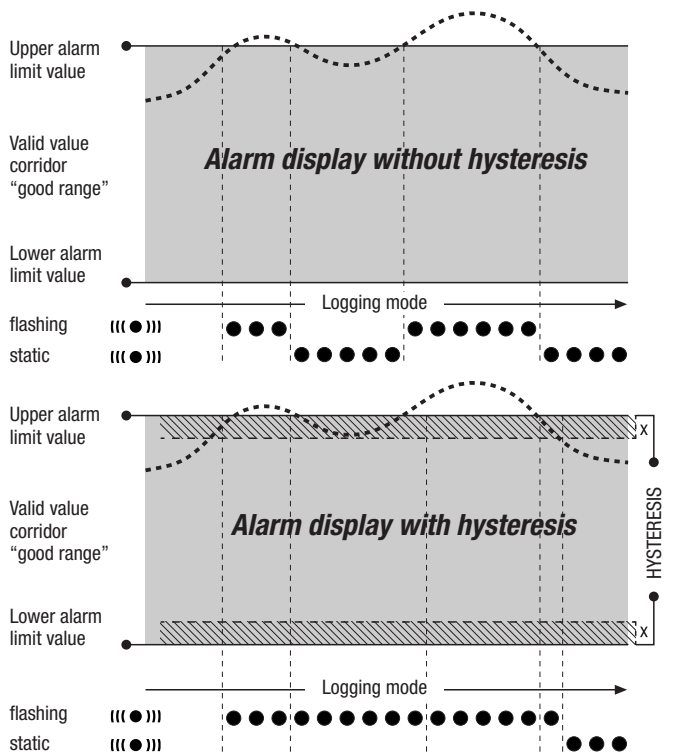

10. Notes on maintenance and operation

10.1. Battery change

If "LO bAtt" appears in the upper row of the display, then the batteries need to be changed.



No data can be recorded while batteries are being changed. If data recording is running, pause it and ensure that the data logger is in operating mode M1 or M2 before changing the batteries.

To replace the batteries, open the battery compartment, remove the used batteries and then insert new batteries, while observing the correct poles.



**Choking hazard:
Keep batteries out of children's reach.**

The time is maintained for at least a minute during battery change, even when batteries are not inserted.

Do not use rechargeable batteries!

Only use appropriate batteries which comply with the technical data. Other types of batteries can cause operating errors.



Risk of leakage: Please remove the batteries from the device during longer periods of inactivity.

Recommendation: Use Varta Industrial Alkaline (LR6/AA) batteries.

Do not dispose of used batteries in the household rubbish or throw them in the fire; instead, dispose of them according to the relevant legal requirements.

10.2. Deleting measured data

The detected measured data are permanently saved in the internal Flash memory. Even when resetting the device to factory settings or when there are no batteries in the device, the measurement data remains in the memory and is not deleted.

Saved data can only be deleted via the SmartGraph3 software as a whole and not individually.

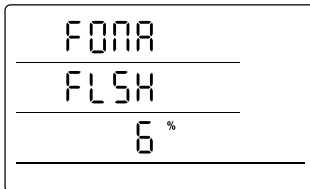

*Display for deleting measured data.
In the display, 6 % of the data have been deleted so far.*

The deletion process takes approx. 2 minutes. During this time, the following messages appears on the display: "FOMA FLSH xxx %".

During the entire deleting period, access to the device is not possible and it does not respond to requests from the SmartGraph3 software.

After memory has been completely deleted, "FOMA FLSH 100 %" is shown

on the display. Afterwards, the display returns to normal operation.

Further detailed information about using the software is provided in the software manual which you can open from the help function of the SmartGraph software.

10.3. Positioning for mobile use

For mobile measured value recording, the data logger can be positioned at any site. Observe the permissible ambient conditions for operation (see technical data). Due to its compact dimensions, the data logger can be hidden for non-intrusive applications.

10.4. Mounting on a wall

For stationary data detection, the data logger can also be mounted on a wall or a similar holding device. A mount track is included in the scope of supply for fastening.



**For network operation, wall mounting is absolutely necessary.
Additional information about network operation is provided in chapter 6.2.2.**

10.5. Moving to another site

Especially when moving from cold to warm ambient conditions, e.g. when moving into a heated room after storage in a car over night, depending on humidity in the room, condensation may form on the printed circuit board.

This physical trait can lead to false measured values. Unfortunately, it is necessary for the construction and cannot be prevented in any measuring devices. In these cases, please wait approx. 5 minutes until the measuring device has "acclimatised" before starting to measure.

10.6. Measuring accuracy

The measuring accuracy of external analog sensors may be affected by high-frequency interference. Motor cables and power supply units can generate strong electromagnetic fields, which may restrict the measuring accuracy if cables are laid and sensors positioned unfavourably. For example, the measuring accuracy of a Pt100 temperature sensor may drop from $\pm 0,2$ °C to ± 2 °C. The use of separate voltage supplies and installation in shielded switch cabinets can prevent interference in critical ambient conditions.

10.7. Installation and operation with Ethernet (with or without PoE)

To avoid measurement inaccuracies caused by high-frequency interference, it is necessary to use a shielded Ethernet cable and connect its cable shield to earth (PE). This should be done using at least one grounded patch panel. In the case of a switch cabinet installation, earthing using shield terminals near the device is recommended!

10.8. Cleaning

The use of aggressive cleaning agents in the vicinity of the DL200X may damage the humidity sensor beyond repair.

If the DL200X needs cleaning, use only a damp cloth, adding commercially available dishwashing detergent, if necessary.

11. Technical data

DL200X data logger for external sensors		
Voltage input 0 - 1 V	Measuring range	0 ... 1 V
	Accuracy	$\pm 200 \mu\text{V} \pm 0.1 \%$ of measured value
	Resolution	$< 500 \mu\text{V}$
Voltage measurement	Measuring range	2-cable operation: 4 ... 20 mA, 3-cable operation: 0 ... 20 mA
	Accuracy	$\pm 4 \mu\text{A} \pm 0.1 \%$ of measured value
	Resolution	$< 5 \mu\text{A}$
	Total load	approx. 50 Ω
Thermal element K	Measuring range	-200 °C ... 1,200 °C
	Accuracy	$\pm 1 \text{ °C} \pm 0.5 \%$ of the measured value at -200 °C ... 0 °C, $\pm 1 \text{ °C} \pm 0.2 \%$ of the measured value at 0 °C ... 1,200 °C
	Resolution	$< 0.2 \text{ °C}$
Thermal element J	Measuring range	-200 °C ... 1,200 °C
	Accuracy	$\pm 1 \text{ °C} \pm 0.5 \%$ of the measured value at -200 °C ... 0 °C, $\pm 1 \text{ °C} \pm 0.2 \%$ of the measured value at 0 °C ... 1,200 °C
	Resolution	$< 0.2 \text{ °C}$
Thermal element S	Measuring range	-50 °C ... 1,700 °C
	Accuracy	$\pm 1 \text{ °C} \pm 0.5 \%$ of the measured value at -50 °C ... 0 °C, $\pm 1 \text{ °C} \pm 0.2 \%$ of the measured value at 0 °C ... 1,700 °C
	Resolution	$< 0.2 \text{ °C}$
Pt100	Measuring range	-200 °C ... 500 °C
	Accuracy	$\pm 0.2 \text{ °C} \pm 0.1 \%$ of the measured value
	Resolution	$< 0.02 \text{ °C}$
Memory organisation	Sensing interval	10/30 s, 1/10/12/15/30 min, 1/3/6/12/24 h
	Saving interval	1/10/12/15/30 min, 1/3/6/12/24 h
	Data storage	16 MB, approx. 3,200,000 measured values
	Data recording	up to 20 simultaneous measuring channels
Configuration and dimensions	LCD display	W 90 x H 64 mm
	Housing	Plastic
	Dimensions	L 180 x W 32 x H 78 mm
	Weight	approx. 250 g
	Interfaces	USB, LAN, RS485 (Sensor BUS)
Power supply	internal	4 x LR6 AA batteries, battery life > 1 year (depending on connected sensor and configuration)
	external	USB, LAN (PoE configuration), terminals for external power supply to supply the sensor
Permissible operating ambient conditions	Air temperature	-20 °C to +50 °C
	Relative humidity	0 to 95 % RH, < 20 g/m ³ (non-condensing)
	Height	10,000 m above sea level
Scope of supply	Standard	Measuring device, CD-ROM with SmartGraph3 PC software for representing the evaluation of measured values graphically and numerically and operating manual, USB connection cable, batteries
	Optional	Measuring device in PoE configuration, TFF sensors

12. Status codes

In the event of a sensor error, the following codes may appear on one of the three LCD rows instead of the measured value

E 2CInitialisation error at the sensor

E 27Faulty calibration data

E 36Channel disabled (e.g. channel configured in the LCD, but sensor logged off or removed)

E 50Value to be displayed too large to fit on display

E 51Value to be displayed too small to fit on display

E 52Channel value in the saturation (upper limit)

E 53Channel value in the saturation (lower limit)

E 54Data error. Received data are not plausible

E 55Measurement not possible of sensor not reachable

Sensor	Status	Measuring range	Code
0 ... 1 V	Negative polarity	approx. < -0.024 V	0x53 (CHANNEL_UNDERRANGE)
	Limit range	-0.024 V ... 0.000 V	Displayed: 0.000V
	Normal operation mode	0.000 V ... 1.000 V	
	Limit range	1.000 V ... 1.024 V	Displayed: 1.000V
	Overvoltage	approx. > 1.024 V	0x52 (CHANNEL_OVERRANGE)
	Special case: open		Input floating, e.g. CHANNEL_OVERRANGE, so 0x52
4 ... 20 mA	Negative polarity	approx. < -0.48 mA	0x53 (CHANNEL_UNDERRANGE)
	Sensor breakage	approx. -0.48 mA ... 0.30 mA	0x55 (MEAS_UNABLE)
	Fault current	0.30 mA ... 3.00 mA	0x51 (VALUE_UNDERFLOW)
	Limit range	3.00 mA ... 4.00 mA	Displayed: 04.00mA
	Normal operation mode	4.00 mA ... 20.00 mA	
	Limit range	20.00 mA ... 20.48 mA	Displayed: 20.00mA
	Overcurrent	approx. > 20.48 mA	0x52 (CHANNEL_OVERRANGE)
0 ... 20 mA	Negative polarity	approx. < -0.48 mA	0x53 (CHANNEL_UNDERRANGE)
	Limit range	-0.48 mA ... 0.00 mA	Displayed: 0.00mA
	Normal operation mode	0.00 mA ... 20.00 mA	
	Limit range	20.00 mA ... 20.48 mA	Displayed: 20.00mA
	Overcurrent	approx. > 20.48 mA	0x52 (CHANNEL_OVERRANGE)

Trotec GmbH

Grebener Straße 7
52525 Heinsberg

☎ +49 2452 962-400

☎ +49 2452 962-200

info@trotec.com

www.trotec.com